

MCMC MTSFB TC G027:2021

TECHNICAL CODE

IMT-2020 (FIFTH GENERATION) - SYSTEM ARCHITECTURE AND SPECIFICATIONS

Developed by



Registered by



Registered date: 24 August 2021

© Copyright 2021

MCMC MTSFB TC G027:2021

Development of technical codes

The Communications and Multimedia Act 1998 ('the Act') provides for Technical Standards Forum designated under section 184 of the Act or the Malaysian Communications and Multimedia Commission ('the Commission') to prepare a technical code. The technical code prepared pursuant to section 185 of the Act shall consist of at least, the requirement for network interoperability and the promotion of safety of network facilities.

Section 96 of the Act also provides for the Commission to determine a technical code in accordance with section 55 of the Act if the technical code is not developed under an applicable provision of the Act and it is unlikely to be developed by the Technical Standards Forum within a reasonable time.

In exercise of the power conferred by section 184 of the Act, the Commission has designated the Malaysian Technical Standards Forum Bhd (MTSFB) as a Technical Standards Forum which is obligated, among others, to prepare the technical code under section 185 of the Act.

A technical code prepared in accordance with section 185 shall not be effective until it is registered by the Commission pursuant to section 95 of the Act.

For further information on the technical code, please contact:

Malaysian Communications and Multimedia Commission (MCMC)

MCMC Tower 1
Jalan Impact
Cyber 6
63000 Cyberjaya
Selangor Darul Ehsan
MALAYSIA

Tel: +60 3 8688 8000
Fax: +60 3 8688 1000
<http://www.mcmc.gov.my>

OR

Malaysian Technical Standards Forum Bhd (MTSFB)

MCMC Centre of Excellence (CoE)
Off Persiaran Multimedia
Jalan Impact
63000 Cyberjaya
Selangor Darul Ehsan
MALAYSIA

Tel: +60 3 8320 0300
Fax: +60 3 8322 0115
<http://www.mtsfb.org.my>

Contents

	Page
Committee representation.....	ii
Foreword	iii
0. Introduction	1
1. Scope	3
2. Normative references.....	4
3. Abbreviations	4
4. Terms and definitions.....	4
4.1 Access Network (AN)	4
4.2 Core Network (CN).....	4
4.3 Enhanced Mobile Broadband (eMBB).....	4
4.4 Frequency Division Duplex (FDD).....	4
4.5 Massive Machine Type Communications (mMTC)	4
4.6 Massive Multiple-Input and Multiple-Output (MIMO).....	4
4.7 Non-standalone (NSA)	5
4.8 Standalone (SA)	5
4.9 Time Division Duplex (TDD).....	5
4.10 Ultra-Reliable Low Latency Communications (URLLC)	5
5. General requirements	5
5.1 5G usage scenarios technical performance.....	6
5.2 5G system architecture	6
6. 5G SA system	6
6.1 5G AN.....	7
6.2 5G CN.....	9
6.3 5G Quality of Service (QoS).....	12
6.4 Frequency	16
Annex A Normative reference.....	20
Annex B Abbreviations	23
Annex C IMT-2020 radio interface technical performance	26
Bibliography	40

MCMC MTSFB TC G027:2021

Committee representation

This technical code was developed by the International Mobile Telecommunications 2020 Sub Working Group under the International Mobile Telecommunications and Future Networks Working Group of the Malaysian Technical Standards Forum Bhd (MTSFB) which consists of representatives from the following organisations:

Celcom Axiata Berhad

Digi Telecommunications Sdn Bhd

Fraunhofer IIS

Huawei Technologies (Malaysia) Sdn Bhd

International Islamic University Malaysia

Maxis Broadband Sdn Bhd

Multimedia University

Orbitage Sdn Bhd

Rohde & Schwarz Malaysia Sdn Bhd

Tekmark Sdn Bhd

Telekom Malaysia Berhad

U Mobile Sdn Bhd

Universiti Kebangsaan Malaysia

Universiti Putra Malaysia

Universiti Teknikal Malaysia Melaka

Universiti Teknologi Malaysia

Universiti Tun Hussein Onn Malaysia

Webe Digital Sdn Bhd

Wideminds Pte Ltd

Xcelcius Consultancy Sdn Bhd

YTL Communications Sdn Bhd

Foreword

This technical code for IMT-2020 (Fifth Generation) - System Architecture and Specifications ('this Technical Code') was developed pursuant to Section 95 and Section 185 of the Act 588 by the Malaysian Technical Standards Forum Bhd ('MTSFB') via its International Mobile Telecommunications and Future Networks Working Group.

This Technical Code shall continue to be valid and effective from the date of its registration until it is replaced or revoked.

(THIS PAGE IS INTENTIONALLY LEFT BLANK)

IMT-2020 (FIFTH GENERATION) - SYSTEM ARCHITECTURE AND SPECIFICATIONS

0. Introduction

This Technical Code refers to the IMT-2020 system architecture and specifications, also known as 5G, which is based on radio interfaces defined in Recommendation ITU-R M.2150. It is fulfilling the requirements and evaluation criteria for the development of IMT-2020 which is defined in Reports ITU-R M.2410 and ITU-R M.2412. The terrestrial radio interfaces for IMT-2020 specified in this Technical Code are based on requirements from 3GPP Set of Radio Interface Technologies (SRIT) and 3GPP 5G Radio Interface Technologies (RIT). In addition, this Technical Code also provides, details, features, parameters and specifications of the core network architecture of IMT-2020, based on the requirements of Recommendations ITU-T Y.3101, ITU-T Y.3102 and ITU-T Y.3104.

5G is designed to support a diverse range of services with different data traffic profiles (e.g. high throughput, low latency and massive connection numbers) and models (e.g. Internet Protocol (IP) data traffic, non-IP data traffic, short data bursts and high throughput data transmission). Various Protocol Data Unit (PDU) session types are supported including Internet Protocol version 4 (IPv4), Internet Protocol version 6 (IPv6), Internet Protocol version 4 and version 6 (IPv4v6), Ethernet and unstructured. The main characteristic of 5G is the introduction of a new radio network interface, known as New Radio (NR), which offers the flexibility needed to support these very different types of services.

A 5G Access Network (AN) connected to a 5G Core Network (CN) is referred to as Standalone (SA) architecture. A second option, known as Non-Standalone (NSA) architecture, makes the 5G NR available without the need to deploy a 5G CN. Note that it is only in a SA configuration where there is a 5G CN and 5G AN that the full set of Phase 1 services are supported.

The main difference between NSA and SA is that NSA uses the 4G/Long Term Evolution (LTE) CN, also known as Evolved Packet Core (EPC), to connect to the 4G and 5G base stations. In the SA scheme, the 5G base station is directly connected to the 5G CN and the control signalling does not depend on the 4G network at all.

In the NSA architecture that supports 3GPP Release 15, also known as Evolved Universal Terrestrial Radio Access New Radio Dual Connectivity (EN-DC) or architecture option 3, there are 3 variants supported as shown below in Figure 1. In this diagram, the Next Generation E-Node B (ng-eNB) is the enhanced LTE base station and the G-Node B (gNB) is the 5G base station.

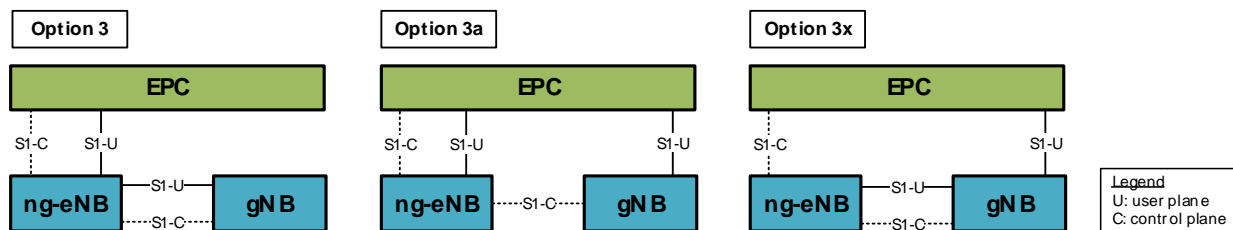

Figure 1. 5G NSA options using the LTE EPC

MCMC MTSFB TC G027:2021

A 5G SA network implementation that supports 3GPP Release 15 is illustrated in Figure 2 below.

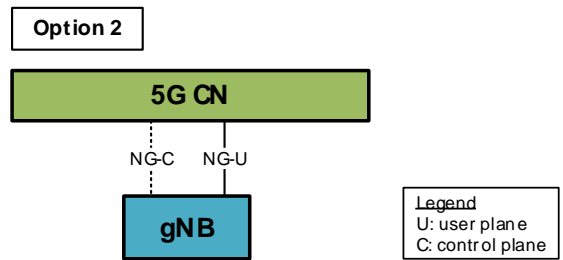

Figure 2. 5G SA configuration

3GPP also incorporates NSA variants using the 5G CN to support 4G/LTE and 5G Radio Access Networks (RAN), as shown in Figure 3 below. This gives much flexibility to operators in how they deploy their 5G networks.

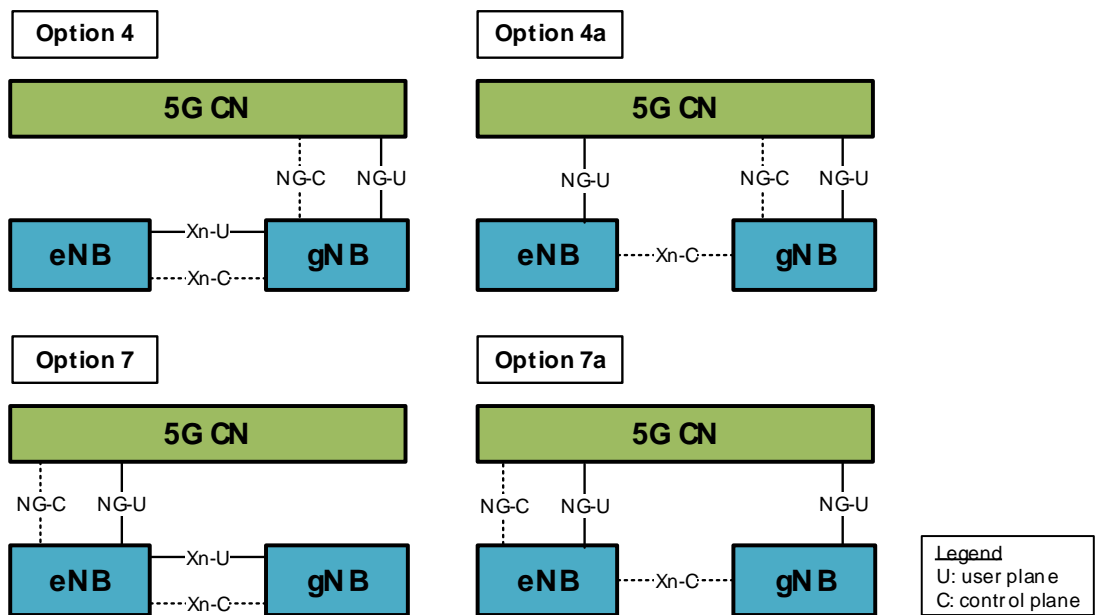

Figure 3. NSA deployment variations using the 5G CN

The terminologies used in 3GPP's 5G architecture options, as discussed earlier in this clause, are aligned with the Recommendation ITU-R M.2150 and this is depicted in Table 1. An important element in the 5G system architecture variations shown in Table 1 is the option involving Multi-Radio Dual Connectivity (MR-DC), whereby a UE is configured to utilise two radio resources provided by eNB or gNB as master node and eNB or gNB as secondary node. The various MR-DC deployment options are aligned with the 5G Architecture options 1, 2, 3, 4, 5 and 7 and these options are explained in Recommendation ITU-R M.2150, 3GPP TS 38.300, 3GPP TS 37.340 as well as 3GPP TR 38.801.

Table 1. SA & NSA deployment variations and the respective terminologies

Standard	5G architecture	Terminology used in the standard		
		EPC	5GCN	
3GPP TR 38.801	SA	Option 1	Option 2	Option 5
Recommendation ITU-R M.2150		SA	NR-DC	SA
3GPP TS 38.300 3GPP TS 37.340		SA	NR-DC	SA
3GPP TR 38.801	NSA	Option 3, 3a, 3x	Option 4, 4a, 4x	Option 7, 7a, 7x
Recommendation ITU-R M.2150	MR-DC	EN-DC	NE-DC	NGEN-DC
3GPP TS 38.300 3GPP TS 37.340	MR-DC	EN-DC	NE-DC	NGEN-DC
SA : Standalone NSA : Non-Standalone MR-DC : Multi Radio Dual Connectivity EN-DC : Evolved Universal Terrestrial Radio Access New Radio (E-UTRA-NR) Dual Connectivity NE-DC : NR E-UTRA Dual Connectivity NR-DC : New Radio Dual Connectivity NGEN-DC : Next Generation Radio Access Network (NG-RAN) E-UTRA-NR Dual Connectivity NOTE: Option 1 represents today's 4G deployments				

On the CN side, the 5G system also makes available a wide array of new characteristics, including the use of network slicing, mobile edge computing and network capability exposure.

1. Scope

This Technical Code specifies system architecture and specifications for the following items below:

- a) terrestrial radio interface for IMT-2020 which consist of 3GPP 5G SRIT and 3GPP 5G RIT based on the Recommendation ITU-R M.2150; and
- b) core network architecture for IMT-2020 which consist of 3GPP 5G CN based on ITU-T recommendations.

MCMC MTSFB TC G027:2021

2. Normative references

The following normative references are indispensable for the application of this Technical Code. For dated references, only the edition cited applies. For undated references, the latest edition of the normative references (including any amendments) applies.

See Annex A.

3. Abbreviations

For the purposes of this Technical Code, the following abbreviations apply.

See Annex B.

4. Terms and definitions

For the purposes of this Technical Code, the following terms and definitions are applied.

4.1 Access Network (AN)

An AN is a user network that connects subscribers to a particular service provider and through the carrier network to other networks such as the Internet.

4.2 Core Network (CN)

A CN is the centralised elements of a telecommunications network which offer a range of services to customers who are interconnected via the AN. This term is also known as network core or backbone network.

4.3 Enhanced Mobile Broadband (eMBB)

This usage scenario pertains to high data rates, high user density, high user mobility, highly variable data rates, deployment and coverage. The enhanced mobile broadband will come with new application areas and requirements in addition to existing mobile broadband applications for improved performance and an increasingly seamless user experience.

4.4 Frequency Division Duplex (FDD)

Frequency Division Duplex (FDD) uses 2 frequency bands in which one is used for transmission and another for reception.

4.5 Massive Machine Type Communications (mMTC)

This usage scenario is characterised by a very large number of connected devices typically transmitting a relatively low volume of non-delay-sensitive data. Devices are required to be low cost, and to have a very long battery life.

4.6 Massive Multiple-Input and Multiple-Output (MIMO)

Massive Multiple-Input and Multiple-Output (MIMO) is seen as a key technology to support delivery of mobile 5G. Massive MIMO is an extension of MIMO which essentially groups together antennas at the transmitter and receiver to provide better throughput and enhanced spectral efficiency.

4.7 Non-standalone (NSA)

The NSA mode of 5G NR refers to an option for 5G NR deployment that depends on the control plane of an existing LTE network for control functions, while 5G NR is focused on the user plane.

4.8 Standalone (SA)

The SA mode of 5G NR refers to the use of 5G cells for both signalling and information transfer.

4.9 Time Division Duplex (TDD)

Time Division Duplex (TDD) uses a single frequency band for both transmit and receive. It shares a single band by assigning alternating time slots to transmit and receive operations.

4.10 Ultra-Reliable Low Latency Communications (URLLC)

This usage scenario has stringent requirements for capabilities such as throughput, latency and reliability. Some examples include wireless control of industrial manufacturing or production processes, remote medical surgery, distribution automation in a smart grid, transportation safety, etc.

5. General requirements

The 5G system requirements shall be able to support different usage scenarios with flexible network operation:

a) eMBB

The eMBB refers to a usage scenario related to higher data rates, higher density, higher user mobility, fixed mobile convergence and small-cell deployments. This usage scenario is covered starting from 3GPP Release 15 in terms of AN and CN.

b) mMTC

mMTC focuses on a usage scenario with a massive number of devices (e.g. sensors and wearables) relevant to vertical services, such as smart home and city, smart utilities, e-Health and smart wearables. This usage is covered starting from 3GPP Release 16 as part of 5G evolution on the CN. The AN is defined as early as 3GPP Release 13, with the introduction of options such as Narrowband Internet of Things (NB-IoT) and Enhanced Machine Type Communication (eMTC).

c) URLLC

The URLLC usage scenario focuses on improving latency, reliability and availability to enable, for example, industrial control applications, mission critical communications and tactile Internet with an improved radio interface, optimized architecture and dedicated core and radio resources. The AN is covered starting from 3GPP Release 15 with further enhancements to the AN and CN in 3GPP Release 16.

d) Flexible network operation

Flexible network operation addresses the functional system requirements, including aspects such as flexible functions and capabilities, new value creation, migration and interworking, optimisation and enhancements and security. This usage is covered starting from 3GPP Release 15.

The above requirements are in line with the overall objectives of the future development of IMT-2020 and beyond defined in Recommendation ITU-R M.2083-0 and also requirements defined in Recommendation ITU-T Y.3101.

MCMC MTSFB TC G027:2021

5.1 5G usage scenarios technical performance

The 5G radio interface technical performance for various usage scenario shall meet the requirements of Report ITU-R M.2410-0 as defined in Annex C. The summary of the requirements are as below:

a) eMBB

The minimum requirement for user experienced data rate is 100 Mbps Downlink (DL) and 50 Mbps Uplink (UL) for a dense urban environment. The user experienced data rate or cell edge data rate is the 5% point of the Cumulative Distribution Function (CDF) of the user throughput. The assumed DL/UL aggregated system bandwidth (for FDD) or overall aggregated system bandwidth (for TDD) is based on aggregation of multiple component carriers as defined in 5.5 of 3GPP TR 37.910. The minimum requirement for user plane latency assuming unloaded conditions (i.e. a single user) for small IP packets (e.g. 0 byte payload + IP header), for both DL and UL is 4 ms. The evaluation of user plane latency is based on the procedure defined in Report ITU-R M.2412-0.

b) mMTC

The minimum requirement for capacity targets or connection density is 1,000,000 devices/km² for an urban macro environment. Connection density is the system capacity metric defined as the total number of devices fulfilling a specific Quality of Service (QoS) per unit area (per km²) with 99% Grade of Service (GoS). The required QoS is that a 32-byte packet is successfully received within 10 s. The evaluation of user plane latency is based on the procedure defined in Report ITU-R M.2412-0.

c) URLLC

End to end latency targets, an important performance indicator for 5G, are as low as 1 ms to 10 ms for automotive and automation interaction. The minimum requirement for user plane latency assuming unloaded conditions (i.e. a single user) for small IP packets (e.g. 0 byte payload + IP header), for both DL and UL is 1 ms. The evaluation of user plane latency is based on the procedure defined in Report ITU-R M.2412-0.

5.2 5G system architecture

The 5G system architecture shall be deployed as either:

- a) NSA architecture where the 5G RAN and its NR interface is used in conjunction with the existing LTE and EPC (respectively 4G radio and 4G core), thus making the NR technology available without network replacement. The NSA architecture is reflected in Figure 1. EN-DC offering dual connectivity via both the upgraded 4G AN and the 5G AN using 5G CN, as defined in 3GPP TS 37.340, is also known as NSA as illustrated in Figure 3; or
- b) SA architecture where the NR is connected to the 5G CN. The SA architecture is shown in Figure 2.

The NSA architecture shall support at least the eMBB service whereas the SA architecture shall be able to meet full compliance to 5G, supporting eMBB, mMTC and URLLC. The NSA architecture deployment is aligned with the requirements of IMT-2020 network deployment and migration as defined in Recommendation ITU-T Y.3101. The IMT-2020 network should support incremental deployment methods and to support the migration processes of services and related users from legacy networks.

6. 5G SA system

The 5G SA system consists of a 5G AN connected to a 5G CN via the Next Generation (NG) interface followed the architecture reference model of the IMT-2020 network in Recommendation ITU-T Y.3104.

The 5G CN shall use a Service-Based Architecture (SBA) framework where the architecture elements are defined in terms of Network Function (NF) offering modularity and reusability in accordance with Recommendation ITU-T Y.3102.

The following splits between the 5G AN and 5G CN shall be implemented in accordance with 3GPP TS 38.300:

- a) 5G AN; and
 - i) inter cell radio resource management;
 - ii) resource block control;
 - iii) connection mobility control;
 - iv) radio admission control;
 - v) measurement configuration and provision; and
 - vi) dynamic resource allocation.
- b) 5G CN.
 - i) Network Attached Storage (NAS) security;
 - ii) idle state mobility handling;
 - iii) mobility anchoring;
 - iv) PDU handling;
 - v) UE IP address allocation; and
 - vi) PDU session control.

6.1 5G AN

A 5G AN shall consist of a set of gNBs connected to the 5G CN. The gNB can be connected to another gNB via the X_n interface. A gNB shall be able to be further split into a gNB-Central Unit (gNB-CU) and one or more gNB-Distributed Unit(s) (gNB-DU) linked by the F1 interface as defined in 3GPP TS 38.401. The 5G RAN architecture emphasising on 5G AN (NG-RAN) and 5G CN (5GC) are shown in Figure 4.

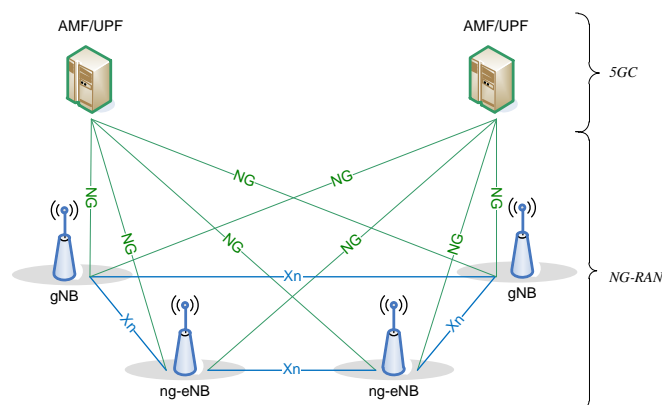

Figure 4. 5G RAN Architecture

MCMC MTSFB TC G027:2021

The gNB shall be able to perform the following functions as stipulated in 3GPP TS 38.300:

- a) functions for radio resource management which are radio bearer control, radio admission control, connection mobility control, dynamic allocation of resources to use in both UL and DL (scheduling);
- b) IP header compression, encryption and integrity protection of data;
- c) selection of an Access and Mobility Management Function (AMF) at UE attachment when no routing to an AMF can be determined from the information provided by the UE;
- d) routing of user plane data towards User Plane Functions (UPF);
- e) routing of control plane information towards AMF;
- f) connection setup and release;
- g) scheduling and transmission of paging messages;
- h) scheduling and transmission of system broadcast information originated from the AMF or operation and maintenance;
- i) measurement and measurement reporting configuration for mobility and scheduling;
- j) transport level packet marking in the UL;
- k) session management;
- l) support of network slicing;
- m) QoS flow management and mapping to data radio bearers;
- n) support of UEs in Radio Resource Control (RRC) inactive state;
- o) distribution function for NAS messages;
- p) RAN sharing;
- q) dual connectivity; and
- r) tight interworking between NR and Evolved Universal Terrestrial Radio Access (E-UTRA).

6.1.1 Radio physical layer

The 5G AN shall support the use of Orthogonal Frequency Division Multiplexing (OFDM) with Cyclic Prefix (CP) as the NR waveform for both DL and UL in addition to the use of Discrete Fourier Transform precoding (DFT-s-OFDM) as the UL waveform for UL coverage improvement.

The 5G AN shall support NR channel bandwidths as indicated in Table 2 for various deployment scenarios.

Table 2. NR channel bandwidth

Frequency range	Frequency band (MHz)	Supported channel bandwidth (MHz)
FR1	410 - 7 125	5, 10, 15, 20, 25, 30, 40, 50, 60, 80, 90, 100
FR2	24 250 - 52 600	50, 100, 200, 400

6.1.2 MIMO

The 5G AN shall support multi-layer data transmission for a single UE on single-user MIMO with a maximum of 8 transmission layers for DL and 4 for UL. Also, the 5G AN shall be able to support multi-layer data transmission with multiple UEs on multi-user MIMO with a maximum of 12 transmission layers for DL and UL transmission.

6.1.3 New Radio - Long Term Evolution (NR-LTE) co-existence

The 5G AN shall support NR DL/UL transmission within the bandwidth of an LTE carrier without impact on legacy LTE devices.

6.1.4 Supplementary Uplink (SUL)

The 5G AN shall be able to support the configuration of a UE with 2 ULs consisting of a normal UL and Supplementary Uplink (SUL) for 1 DL in the same cell.

6.1.5 UL Transmit Power Control (TPC)

The 5G AN shall support dynamic power adjustment for relevant physical channels.

The above requirements are defined in 3GPP TR 21.915.

6.2 5G CN

The 5G CN shall consist of the following main Network Functions (NF) in accordance with Recommendation ITU-T Y.3102:

- a) AMF shall provide functions similar to those performed by the Mobility Management Entity (MME) in a 4G network, including NAS signalling, mobility management, registration management, connection management, reachability management, Session Management (SM) message forwarding and access authentication/authorisation;
- b) Session Management Function (SMF) shall provide the session management functions that are handled by MME, Serving Gateway Control (SGW-C) and Packet Data Network Gateway Control (PGW-C) in a 4G network, including UE IP address allocation and management, NAS signalling for session management, configuring traffic steering at the UPF, lawful interception CP, DL data notification, sending QoS and policy information to RAN and supporting charging interfaces;
- c) UPF shall provide the data plane functionality that is performed by the SGW and PGW in a 4G network, including packet routing and forwarding, lawful interception of the user plane, mobility anchor points for intra-/inter-Radio Access Technology (RAT) mobility and traffic usage reporting;
- d) Network Repository Function (NRF) shall provide functions such as service registration and discovery function which allows network functions to discover each other, as well as maintaining the NF profile of available NF instances and their support services;

MCMC MTSFB TC G027:2021

- e) Network Exposure Function (NEF) shall provide functions such as exposing capabilities and events, securing provision of information from external applications to a 3GPP network, translating internal/external information and managing packet flow descriptions;
- f) Unified Data Management (UDM) shall provide functions similar to the HSS in a 4G network, such as generation of Authentication and Key Agreement (AKA) credentials, handling of user identification, access authorisation based on subscription data and management of subscriptions; and
- g) Unified Data Repository (UDR) shall provide function such as a common data storage function for all types of 2G/3G/4G/5G subscription and policy data. It shall provide a distributed, central data repository and a unified data model for all kinds of applications in a telecoms network. All data stored in the UDR can be accessed through single data access points from the whole network and it is accessible both for traffic and provisioning components. The 3GPP defined Nudr interface is used by the UDM, Policy Control Function (PCF) and NEF to access a particular set of data stored in UDR as defined in 3GPP TS 29.504.
- h) Network Slice Selection Function (NSSF) as defined in Recommendation ITU-T Y.3112 shall provide functions such as selecting the set of NS instances serving the UE, determining the allowed Network Slice Selection Assistance Information (NSSAI) as well as determining the AMF set to be used to serve the UE; and
- i) PCF shall provide functions such as governing network behaviour via the unified policy framework, providing policy rules to control plane functions and accessing subscription information relevant for policy decisions stored in a UDR.

More details on the functionality of the above NFs can be found in 3GPP TS 23.501.

The 5G CN shall consist of the following security related NFs as defined in MCMC MTSFB TC G028 which in accordance to the deployment scenarios as follows:

- a) Security Anchor Function (SEAF) shall provide the authentication functionality via the AMF in a serving network and support primary authentication using the Subscription Concealed Identifier (SUCI);
- b) Authentication Server Function (AUSF) shall provide authentication functions similar to the HSS in the 4G network, supporting authentication for both 3GPP access and untrusted non-3GPP access. It shall provide the Subscription Permanent Identifier (SUPI) to the Visited Public Land Mobile Network (VPLMN) only after authentication confirmation is received from the Home Public Land Mobile Network (HPLMN). This will be sent if an authentication request with a valid SUCI was sent by the VPLMN;
- c) Authentication Credential Repository and Processing Function (ARPF) shall provide the functionality of storing credentials associated with authentication and security procedures;
- d) Security Edge Protection Proxy (SEPP) shall support the interconnection of the home and visited networks. It acts as a non-transparent proxy node and perform topology hiding by limiting the internal topology information visible to external parties; and
- e) Subscription Identifier De-Concealing Function (SIDF) shall be responsible for de-concealment of the SUCI and shall be a service offered by the UDM to resolve the SUPI from the SUCI based on the protection scheme used to generate the SUCI.

More details on the functionality of the above NFs can be found in 3GPP TS 23.501 and 3GPP TS 33.501.

Overall, the 5G CN shall fulfil the general principles of an IMT-2020 network defined in 7 of Recommendation ITU-T Y.3101.

6.2.1 Local hosting of services and edge computing

The 5G CN shall select a UPF in close proximity to the UE for traffic steering purposes to support URLLC services by hosting the services using mobile edge computing capabilities, thus reducing the latency in accessing services. As mentioned in the distributed network architecture of Recommendation ITU-T Y.3101, this brings a significant reduction of backhaul and core network traffic by enabling the placement of content servers closer to the end user devices and also is beneficial in terms of service latency.

6.2.2 Network slicing

The 5G CN shall support end-to-end network slicing as per requirements of Recommendations ITU-T Y.3110, ITU-T Y.3111, ITU-T Y.3112 and ITU-T Y.3153 for each deployed Public Land Mobile Network (PLMN) to the extent necessary to interoperate with other PLMNs, e.g. the IoT slice from Operator A can interconnect directly with the IoT slice of Operator B.

The 5G CN shall be able to support QoS for 3 types of predefined slice as follows:

- a) type 1 is dedicated to the support of eMBB;
- b) type 2 is for URLLC; and
- c) type 3 is for mMTC support.

Network flexibility and programmability is an important requirement from a network operation point of view for an IMT-2020 network, as specified in Recommendation ITU-T Y.3101.

6.2.3 Support of 3GPP and Non-3GPP access

The 5G CN shall support 3GPP access technologies, such as 5G NR and 4G E-UTRA as well as non-3GPP access technologies, even non-trusted ones, to fulfil the requirements of an IMT-2020 network supporting fixed mobile convergence as well as interworking with non-IMT-2020 networks as specified in Recommendation ITU-T Y.3101. The requirements of fixed mobile convergence are further described in Recommendation ITU-T Y.3130 with functional architecture as illustrated in Recommendation ITU-T Y.3131.

6.2.4 Network capability exposure

The 5G CN shall support the Service Exposure and Enablement Support (SEES) and enhanced Flexible Mobile Service Steering (FMSS) features to expose network capabilities to third parties as per the requirements of Recommendations ITU-T Y.3105 and ITU-T Y.3108. Section 9.4 of Recommendation ITU-T Y.3101 states that an IMT-2020 network should be able to expose network capabilities to third party applications located inside or outside the IMT-2020 network operator's domain.

6.2.5 IP-Multimedia Subsystem (IMS) and Short Message Service (SMS)

The 5G CN shall support the IP-Multimedia Subsystem (IMS) and Short Message Service (SMS). This is to align with the requirement of Recommendation ITU-T Y.3101 in support of migration processes of services and related users from legacy networks.

6.2.6 Multi-Operator Core Network (MOCN)

The 5G CN shall support RAN sharing via multiple core networks. This can be implemented as a Multi-Operator Core Network (MOCN), where radio access networks and spectrum are shared, or as a

MCMC MTSFB TC G027:2021

Multi-Operator Radio Access Network (MORAN), where radio access networks are shared and dedicated spectrum is used by each sharing operator. The technical classification of MOCN and MORN are shown in Figure 5. The overview of the infrastructure sharing is specified in the GSMA report as well as 3GPP TR 38.801.

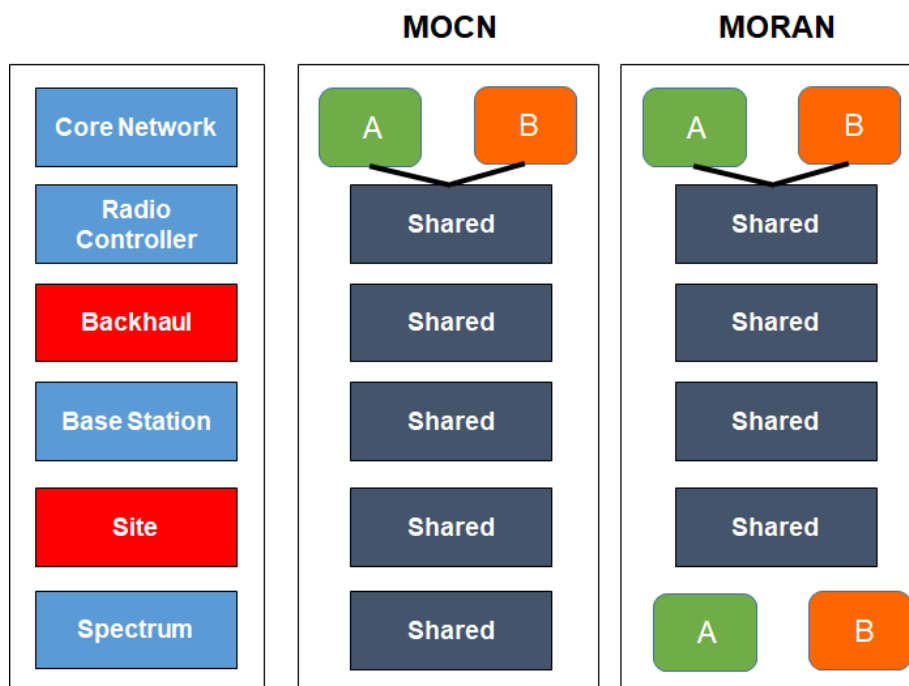

Figure 5. Technical classification of MOCN and MORAN infrastructure sharing

6.2.7 Roaming

The standard network architecture for either SA or NSA supports customer roaming as specified in 3GPP TS 23.501. It is recommended that the 5G CN follows the GSM Association (GSMA) recommendations outlined in NG.113 – 5G Roaming Guidelines which provides a standardised set of guidelines on how 5G networks can interconnect and/or interwork when a user roams to a network different to their Home Public Land Mobile Network (HPLMN).

6.3 5G Quality of Service (QoS)

The 5G network shall fulfil the QoS functional requirements for the IMT-2020 network defined in Recommendation ITU-T Y.3106 and support the functional architecture defined in Recommendation ITU-T Y.3107. The 5G network shall have a standardised set of Quality of Service (QoS) characteristics, which are based on the QoS Class Identifier (QCI). The QCI will be aggregated from the multiple sessions of Service Data Flows (SDF). The QCI shall be used as a reference to node specific parameters that control packet forwarding treatment (e.g. scheduling weights, admission thresholds, queue management thresholds, link layer protocol configuration, etc.) and that have been pre-configured by the operator controlling the node e.g. eNB.

The characteristics describe the packet forwarding treatment that an SDF aggregate receives edge-to-edge between the UE and the Policy and Charging Enforcement Function (PCEF) in terms of the following performance characteristics:

- a) resource type (Guaranteed Bit Rate (GBR) or Non-GBR);
- b) priority;

- c) packet delay budget;
- d) packet error loss rate;
- e) maximum data burst volume; and
- f) data rate averaging window.

The scope of the QCI characteristics for client/server communication is shown in Figure 6 while the scope of QCI characteristics for peer-to-peer communication is shown in Figure 7.

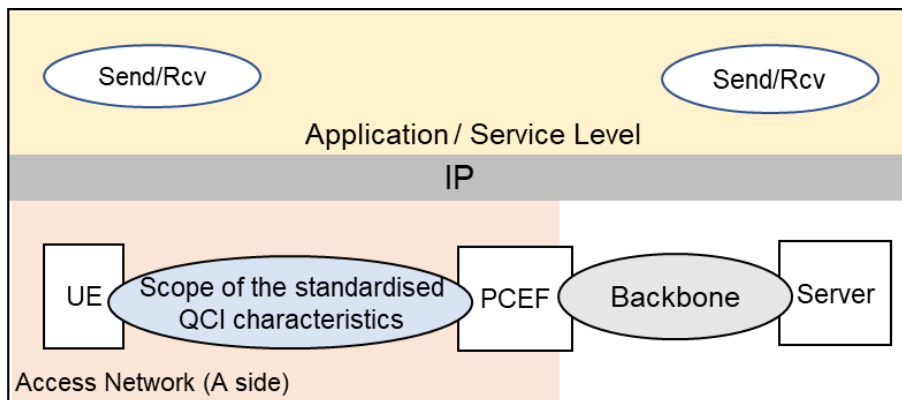

Figure 6. Scope of the QCI characteristics for client/server communication

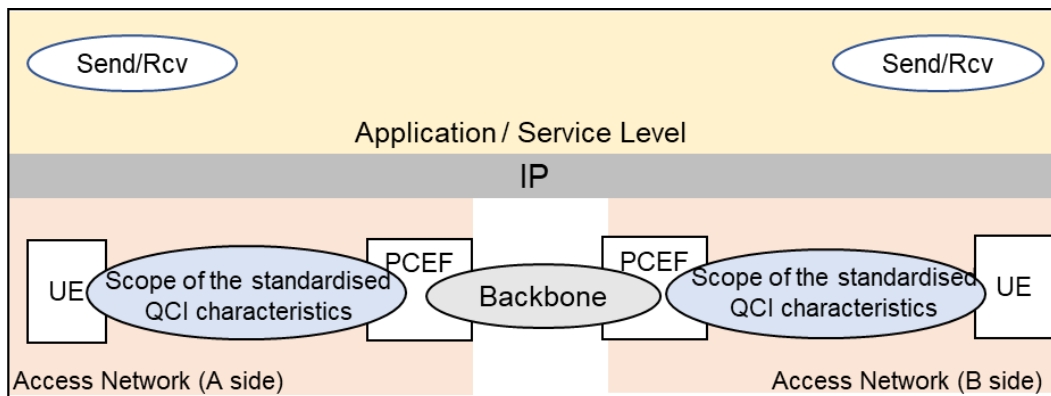

Figure 7. Scope of the QCI characteristics for peer-to-peer communication

The one-to-one mapping of standardised QCI values to standardised characteristics as outlined in 3GPP TS 23.203 is tabulated in Table 3.

Table 3. Standardised QCI characteristics

QCI	Resource type	Priority level	Packet delay budget ^m	Packet error loss rate ^b	Example services
1 ^c	GBR	2	100 ms ^{a,k}	10 ⁻²	Conversational voice
2 ^c		4	150 ms ^{a,k}	10 ⁻³	Conversational video (live streaming)

MCMC MTSFB TC G027:2021

Table 3. Standardised QCI characteristics (continued)

QCI	Resource type	Priority level	Packet delay budget ^m	Packet error loss rate ^b	Example services
3 ^{c,n}	GBR	3	50 ms ^{a,k}	10 ⁻³	a) Real time gaming, Vehicle-to-everything (V2X) messages b) Electricity distribution – medium voltage c) Process automation – monitoring
4 ^c		5	300 ms ^{a,k}	10 ⁻⁶	Non-conversational video (buffered streaming)
65 ^{c,l,i}		0.7	75 ms ^{g,h}	10 ⁻²	Mission critical user plane push to talk voice (e.g. Mission Critical Push to Talk (MCPTT))
66 ^{c,l}		2	100 ms ^{a,j}	10 ⁻²	Non-mission-critical user plane push to talk voice
67 ^{c,l}		1.5	100 ms ^{a,j}	10 ⁻³	Mission critical video user plane
75 ⁿ		2.5	50 ms ^a	10 ⁻²	V2X messages
71	Non-GBR	5.6	150 ms ^{a,p}	10 ⁻⁶	“Live” uplink streaming
72		5.6	300 ms ^{a,p}	10 ⁻⁴	“Live” uplink streaming
73		5.6	300 ms ^{a,p}	10 ⁻⁸	“Live” uplink streaming
74		5.6	500 ms ^{a,p}	10 ⁻⁸	“Live” uplink streaming
76		5.6	500 ms ^{a,p}	10 ⁻⁴	“Live” uplink streaming
5 ^c		1	100 ms ^{a,j}	10 ⁻⁶	IP-Multimedia Subsystem (IMS) signalling
6 ^d		6	300 ms ^{a,j}	10 ⁻⁶	Video (buffered streaming) TCP-based (e.g. www, e-mail, chat, ftp, p2p file sharing, progressive video, etc.)
7 ^c		7	100 ms ^{a,j}	10 ⁻³	a) Voice b) Video (live streaming) Interactive gaming
8 ^e		8	300 ms ^a	10 ⁻⁶	Video (buffered streaming) TCP-based (e.g. www, e-mail, chat, ftp, p2p file)
9 ^f		9	N/A	N/A	Sharing and progressive video
69 ^{c,l,i}		0.5	60 ms ^{g,h}	10 ⁻⁶	Mission critical delay sensitive signalling such as MCPTT signalling, Mission Critical Video (MCVideo) signalling
70 ^{d,l}		5.5	200 ms ^{g,j}	10 ⁻⁶	Mission critical data (e.g. services are the same as QCI 6/8/9)
79 ⁿ		6.5	50 ms ^{a,j}	10 ⁻²	V2X messages

Table 3. Standardised QCI characteristics (continued)

QCI	Resource type	Priority level	Packet delay budget ^m	Packet error loss rate ^b	Example services
80 ^c	Non-GBR	6.8	10 ms ^{j,o}	10 ⁻⁶	a) Low latency eMBB applications (TCP/UDP-based) b) augmented reality
<p>^a A delay of 20 ms for the delay between a PCEF and a radio base station should be subtracted from a given PDB to derive the packet delay budget that applies to the radio interface. This delay is the average between the case where the PCEF is located “close” to the radio base station (roughly 10 ms) and the case where the PCEF is located “far” from the radio base station, e.g. in case of roaming with home routed traffic (the one-way packet delay between Europe and the US west coast is roughly 50 ms). The average takes into account that roaming is a less typical scenario. It is expected that subtracting this average delay of 20 ms from a given PDB will lead to desired end-to-end performance in most typical cases. Also, note that the PDB defines an upper bound. Actual packet delays in particular for GBR traffic should typically be lower than the PDB specified for a QCI as long as the UE has sufficient radio channel quality.</p> <p>^b The rate of non-congestion related packet losses that may occur between a radio base station and a PCEF should be regarded to be negligible. A PELR value specified for a standardised QCI therefore applies completely to the radio interface between a UE and radio base station.</p> <p>^c This QCI is typically associated with an operator controlled service, i.e. a service where the SDF aggregates uplink / downlink packet filters are known at the point in time when the SDF aggregate is authorised. In case of E-UTRAN this is the point in time when a corresponding dedicated EPS bearer is established / modified.</p> <p>^d If the network supports Multimedia Priority Services (MPS) then this QCI could be used for the prioritisation of non-real-time data (i.e. most typically TCP-based services/applications) of MPS subscribers.</p> <p>^e This QCI could be used for a dedicated "premium bearer" (e.g. associated with premium content) for any subscriber/subscriber group. Also in this case, the SDF aggregate's uplink / downlink packet filters are known at the point in time when the SDF aggregate is authorised. Alternatively, this QCI could be used for the default bearer of a UE/PDN for "premium subscriber".</p> <p>^f This QCI is typically used for the default bearer of a UE/PDN for non-privileged subscribers. Note that AMBR can be used as a “tool” to provide subscriber differentiation between subscriber groups connected to the same PDN with the same QCI on the default bearer.</p> <p>^g For Mission Critical services, it may be assumed that the PCEF is located "close" to the radio base station (roughly 10 ms) and is not normally used in a long distance, home routed roaming situation. Hence delay of 10 ms for the delay between a PCEF and a radio base station should be subtracted from this PDB to derive the packet delay budget that applies to the radio interface.</p> <p>^h In both RRC Idle and RRC Connected mode, the PDB requirement for these QCIs can be relaxed (but not to a value greater than 320 ms) for the first packet(s) in a downlink data or signalling burst in order to permit reasonable battery saving using Discontinuous Reception (DRX) techniques.</p> <p>ⁱ It is expected that QCI-65 and QCI-69 are used together to provide Mission Critical Push to Talk service (e.g. QCI-5 is not used for signalling for the bearer that utilizes QCI-65 as user plane bearer). It is expected that the amount of traffic per UE will be similar or less compared to the IMS signalling.</p> <p>^j In both RRC Idle and RRC Connected mode, the PDB requirement for these QCIs can be relaxed for the first packet(s) in a downlink data or signalling burst in order to permit battery saving DRX techniques.</p> <p>^k In RRC Idle mode, the PDB requirement for these QCIs can be relaxed for the first packet(s) in a downlink data or signalling burst in order to permit battery saving DRX techniques.</p> <p>^l This QCI value can only be assigned upon request from the network side. The UE and any application running on the UE is not allowed to request this QCI value.</p> <p>^m Packet delay budget is not applicable on NB-IoT or when Enhanced Coverage is used for WB-E-UTRAN (see 3GPP TS 36.300).</p> <p>ⁿ This QCI could be used for transmission of V2X messages as defined in 3GPP TS 23.285.</p> <p>^o A delay of 2 ms for the delay between a PCEF and a radio base station should be subtracted from the given PDB to derive the packet delay budget that applies to the radio interface.</p>					

MCMC MTSFB TC G027:2021

Table 3. Standardised QCI characteristics (concluded)

QCI	Resource type	Priority level	Packet delay budget ^m	Packet error loss rate ^b	Example services
<p>^p For "live" uplink streaming (see 3GPP TS 26.238), guidelines for PDB values of the different QCIs correspond to the latency configurations defined in 3GPP TR 26.939. In order to support higher latency reliable streaming services (above 500 ms PDB), if different PDB and PELR combinations are needed these configurations will have to use non-standardised QCIs</p>					

6.4 Frequency

6.4.1 Spectrum identified by ITU for IMT-2020

ITU have categorised 3 frequency ranges for IMT-2020 as follows:

- a) below 1 GHz: for coverage;
- b) 1 GHz to 6 GHz: for capacity/coverage; and
- c) above 24GHz: for capacity.

Guidance on the selection of transmitting and receiving frequency arrangements for the terrestrial IMT in the bands identified in the Radio Regulations Edition of 2020 as shown in Table 5.

Table 5. Frequency bands and footnotes for band identified for IMT

Band (MHz)	Footnotes identifying the band for IMT		
	Region 1	Region 2	Region 3
450 - 470	5.286AA		
470 - 698	N/A	5.295, 5.308A	5.296A
694/698 - 960	5.317A	5.317A	5.313A, 5.317A
1 427 - 1 518	5.341A, 5.346	5.341B	5.341C, 5.346A
1 710 - 2 025	5.384A, 5.388		
2 110 - 2 200	5.388		
2 300 - 2 400	5.384A		
2 500 - 2 690	5.384A		
3 300 - 3 400	5.429B	5.429D	5.429F
3 400 - 3 600	5.430A	5.431B	5.432A, 5.432B, 5.433A
3 600 - 3 700	N/A	5.434	-
4 800 - 4 990	N/A	5.441A	5.441B

Table 5. Frequency bands and footnotes for band identified for IMT (continued)

Band (MHz)	Footnotes identifying the band for IMT		
	Region 1	Region 2	Region 3
24 250 - 27 500	5.338A, 5.532AB		
37 000 - 43 500	5.550B		
43 500 - 47 000	5.553, 5.553A		
47 200 - 48 200	5.553B		
66 000 - 71 000	5.553, 5.559AA		

6.4.2 NR bands

The NR bands are specified in 3GPP Release 16 TS 38.104 is shown in Table 4. The NR bands that shall be applicable for Malaysia are as specified in the MCMC Standard Radio System Plan (SRSP) as indicated in Table 4.

Table 4. NR bands

NR operating band	UL operating band	DL operating band	Duplex mode	Band plan reference
n1	1 920 MHz - 1 980 MHz	2 110 MHz - 2 170 MHz	FDD	-
n2	1 850 MHz - 1 910 MHz	1 930 MHz - 1 990 MHz	FDD	-
n3	1 710 MHz - 1 785 MHz	1 805 MHz - 1 880 MHz	FDD	-
n5	824 MHz - 849 MHz	869 MHz - 894 MHz	FDD	-
n7	2 500 MHz - 2 570 MHz	2 620 MHz - 2 690 MHz	FDD	-
n8	880 MHz - 915 MHz	925 MHz - 960 MHz	FDD	-
n12	699 MHz - 716 MHz	729 MHz - 746 MHz	FDD	-
n20	832 MHz - 862 MHz	791 MHz - 821 MHz	FDD	-
n25	1 850 MHz - 1 915 MHz	1 930 MHz - 1 995 MHz	FDD	-
n28	703 MHz - 748 MHz	758 MHz - 803 MHz	FDD	MCMC SRSP MS 700
n34	2 010 MHz - 2 025 MHz	2 010 MHz - 2 025 MHz	TDD	-
n38	2 570 MHz - 2 620 MHz	2 570 MHz - 2 620 MHz	TDD	-
n39	1 880 MHz - 1 920 MHz	1 880 MHz - 1 920 MHz	TDD	-
n40	2 300 MHz - 2 400 MHz	2 300 MHz - 2 400 MHz	TDD	-
n41	2 496 MHz - 2 690 MHz	2 496 MHz - 2 690 MHz	TDD	-

MCMC MTSFB TC G027:2021

Table 4. NR bands *(continued)*

NR operating band	UL operating band	DL operating band	Duplex mode	Band plan reference
n50	1 432 MHz - 1 517 MHz	1 432 MHz - 1 517 MHz	TDD	-
n51	1 427 MHz - 1 432 MHz	1 427 MHz - 1 432 MHz	TDD	-
n66	1 710 MHz - 1 780 MHz	2 110 MHz - 2 200 MHz	FDD	-
n70	1 695 MHz - 1 710 MHz	1 995 MHz - 2 020 MHz	FDD	-
n71	663 MHz - 698 MHz	617 MHz - 652 MHz	FDD	-
n74	1 427 MHz - 1 470 MHz	1 475 MHz - 1 518 MHz	FDD	-
n75	N/A	1 432 MHz - 1 517 MHz	SDL	-
n76	N/A	1 427 MHz - 1 432 MHz	SDL	-
n77	3 300 MHz - 4 200 MHz	3 300 MHz - 4 200 MHz	TDD	MCMC SRSP MS 3500
n78	3 300 MHz - 3 800 MHz	3 300 MHz - 3 800 MHz	TDD	MCMC SRSP MS 3500
n79	4 400 MHz - 5 000 MHz	4 400 MHz - 5 000 MHz	TDD	-
n80	1 710 MHz - 1 785 MHz	N/A	SUL	-
n81	880 MHz - 915 MHz	N/A	SUL	-
n82	832 MHz - 862 MHz	N/A	SUL	-
n83	703 MHz - 748 MHz	N/A	SUL	-
n84	1 920 MHz - 1 980 MHz	N/A	SUL	-
n86	1 710 MHz - 1 780MHz	N/A	SUL	-
n89	824 - 49 MHz	N/A	SUL	-
n90	2 496 MHz - 2 690 MHz	2 496 MHz - 2 690 MHz	TDD	-
n91	832 MHz - 862 MHz	1 427 MHz - 1 432 MHz	FDD	-
n92	832 MHz - 862 MHz	1 432 MHz - 1 517 MHz	FDD	-
n93	880 MHz - 915 MHz	1 427 MHz - 1 432 MHz	FDD	-
n94	880 MHz - 915 MHz	1 432 MHz - 1 517 MHz	FDD	-
n95	2 010 MHz - 2 025 MHz	N/A	SUL	-
n96	5 925 MHz - 7 125 MHz	5 925 MHz - 7 125 MHz	TDD	-

Table 4. NR bands (concluded)

NR operating band	UL operating band	DL operating band	Duplex mode	Band plan reference
n257	26 500 MHz - 29 500 MHz	26 500 MHz - 29 500 MHz	TDD	MCMC SRSP MS 28000
n258	24 250 MHz - 27 500 MHz	24 250 MHz - 27 500 MHz	TDD	-
n260	37 000 MHz - 40 000 MHz	37 000 MHz - 40 000 MHz	TDD	-
n261	27 500 MHz - 28 350 MHz	27 500 MHz - 28 350 MHz	TDD	-

Annex A
(informative)

Normative reference

Recommendation ITU-R M.2083-0, *IMT Vision, Framework and overall objectives of the future development of IMT for 2020 and beyond*

Report ITU-R M.2410-0, *Minimum requirements related to technical performance for IMT-2020 radio interface(s)*

Report ITU-R M.2412-0, *Guidelines for evaluation of radio interface technologies for IMT-2020*

Recommendation ITU-R M.2150-0, *Detailed specifications of the terrestrial radio interfaces of International Mobile Telecommunications-2020 (IMT-2020) - M Series Mobile, radiodetermination, amateur and related satellite services*

Recommendation ITU-T Y.3101, *Requirement of the IMT-2020 Network - Global, Information Infrastructure, Internet Protocol Aspects, Next Generation Networks, Internet of Things and Smart Cities*

Recommendation ITU-T Y.3102, *Framework of the IMT-2020 network - Global, Information Infrastructure, Internet Protocol Aspects, Next Generation Networks, Internet of Things and Smart Cities*

Recommendation ITU-T Y.3104, *Architecture of the IMT-2020 network - Global, Information Infrastructure, Internet Protocol Aspects, Next Generation Networks, Internet of Things and Smart Cities*

Recommendation ITU-T Y.3105, *Requirements of capability exposure in the IMT-2020 network - Global, Information Infrastructure, Internet Protocol Aspects, Next Generation Networks, Internet of Things and Smart Cities*

Recommendation ITU-T Y.3106, *Quality of service functional requirements for the IMT-2020 network - Global, Information Infrastructure, Internet Protocol Aspects, Next Generation Networks, Internet of Things and Smart Cities*

Recommendation ITU-T Y.3107, *Functional architecture for QoS assurance management in the IMT-2020 network - Global, Information Infrastructure, Internet Protocol Aspects, Next Generation Networks, Internet of Things and Smart Cities*

Recommendation ITU-T Y.3108, *Capability exposure function in IMT-2020 networks - Global, Information Infrastructure, Internet Protocol Aspects, Next Generation Networks, Internet of Things and Smart Cities*

Recommendation ITU-T Y.3110, *IMT-2020 network management and orchestration requirements - Global, Information Infrastructure, Internet Protocol Aspects, Next Generation Networks, Internet of Things and Smart Cities*

Recommendation ITU-T Y.3111, *IMT-2020 network management and orchestration framework - Global, Information Infrastructure, Internet Protocol Aspects, Next Generation Networks, Internet of Things and Smart Cities*

Recommendation ITU-T Y.3112, *Framework for the support of network slicing in the IMT-2020 network - Global, Information Infrastructure, Internet Protocol Aspects, Next Generation Networks, Internet of Things and Smart Cities*

MCMC MTSFB TC G027:2021

Recommendation ITU-T Y.3130, *Requirements of IMT-2020 fixed mobile convergence - Global, Information Infrastructure, Internet Protocol Aspects, Next Generation Networks, Internet of Things and Smart Cities*

Recommendation ITU-T Y.3131, *Functional architecture for supporting fixed mobile convergence in IMT-2020 networks - Global, Information Infrastructure, Internet Protocol Aspects, Next Generation Networks, Internet of Things and Smart Cities*

Recommendation ITU-T Y.3153, *Network slice orchestration and management for providing network services to 3rd party in the IMT-2020 network - Global, Information Infrastructure, Internet Protocol Aspects, Next Generation Networks, Internet of Things and Smart Cities*

Radio Regulations Edition of 2020, ITU

3GPP Release 14: TR 38.801, *3rd Generation Partnership Project; Technical Specification Group Radio Access Network; Study on New Radio Access Technology: Radio Access Architecture and Interface*

3GPP Release 15: TR 21.915, *3rd Generation Partnership Project; Technical Specification Group Services and system Aspects; Release 15 Description; Summary of Rel-15 Work Items*

3GPP Release 15: TR 26.939, *Guidelines on the Framework for Live Uplink Streaming (FLUS)*

3GPP Release 15: TS 29.504, *3rd Generation Partnership Project; Technical Specification Group Core Network and Terminal; 5G System; Unified Data Repository Services; Stage 3*

3GPP Release 15: TS 38.300, *3rd Generation Partnership Project; Technical Specification Group Radio Access Network; NR; NR and NG-RAN Overall Description; Stage 2*

3GPP Release 15: TS 38.401, *3rd Generation Partnership Project; Technical Specification Group Radio Access Network; NG-RAN; Architecture description*

3GPP Release 15: TS 37.340, *3rd Generation Partnership Project; Technical Specification Group Radio Access Network; Evolved Universal Terrestrial Radio Access (E-UTRA) and NR; Multi-connectivity; Stage 2*

3GPP Release 15: TS 23.203, *3rd Generation Partnership Project; 3rd Generation Partnership Project; Technical Specification Group Services and System Aspects; Policy and charging control architecture*

3GPP Release 15: TS 23.501, *3rd Generation Partnership Project; Technical Specification Group Services and System Aspects; System architecture for the 5G system (5GS); Stage 2*

3GPP Release 15: TS 33.501, *3rd Generation Partnership Project; Technical Specification Group Services and System Aspects; Security architecture and procedures for 5G system*

3GPP Release 16: TR 37.910, *3rd Generation Partnership Project; Technical Specification Group Radio Access Network; Study on self-evaluation towards IMT-2020 submission*

3GPP Release 16: TS 23.285, *3rd Generation Partnership Project; Technical Specification Group Services and System Aspects; Architecture enhancements for V2X services*

3GPP Release 16: TS 26.238, *3rd Generation Partnership Project; Technical Specification Group Services and System Aspects; Uplink Streaming*

3GPP Release 16: TS 36.300, *3rd Generation Partnership Project; Technical Specification Group Radio Access Network; Evolved Universal Terrestrial Radio Access (E-UTRA) and Evolved Universal Terrestrial Radio Access Network (E-UTRAN); Overall description; Stage 2*

MCMC MTSFB TC G027:2021

GSM Association, NG.113, *5G Roaming Guidelines v1.0*, December 2019

GSM Association, Report, *Infrastructure Sharing: An Overview*, June 2019

.

Annex B
(informative)

Abbreviations

For the purposes of this Technical Code, the following abbreviations apply.

AKA	Authentication and Key Agreement
AKAAC	Authentication and Key Agreement Access Network
AMF	Access and Mobility Management Function
AN	Access Network
ARPF	Authentication Credential Repository and Processing Function
AUSF	Authentication Server Function
CN	Core Network
CP	Cyclic Prefix
CU	Central Unit
DFT-s-OFDM	Discrete Fourier Transform precoding
DL	Downlink
DU	Distributed Unit
DRX	Discontinuous Reception
eMBB	Enhanced Mobile Broadband
eMTC	Enhanced Machine Type Communication
EN-DC	Evolved Universal Terrestrial Radio Access New Radio Dual Connectivity
EPC	Evolved Packet Core
E-UTRA	Evolved Universal Terrestrial Radio Access
FDD	Frequency Division Duplex
FMSS	Flexible Mobile Service Steering
FR	Frequency Range
GBR	Guaranteed Bit Rate
gNB	G-Node B
gNB-CU	gNB-Central Unit
gNB-DU	gNB-Distributed Unit
GSMA	GSM Association
HPLMN	Home Public Land Mobile Network
IMS	IP-Multimedia Subsystem
IMT-2020	International Mobile Telecommunications 2020
IP	Internet Protocol
IPv4	Internet Protocol version 4
IPv4v6	Internet Protocol version 4 version 6

MCMC MTSFB TC G027:2021

iPv6	Internet Protocol version 6
LTE	Long Term Evolution
LTE-M	Long Term Evolution for Machine
MCPTT	Mission Critical Push to Talk
MCVideo	Mission Critical Video
MEC	Mobile Edge Computing
MIMO	Multiple-Input and Multiple-Output
mIoT	Massive Internet of Things
MME	Mobility Management Entity
mMTC	Massive Machine Type Communications
MOCN	Multi-Operator Core Network
MORAN	Multi-Operator Radio Access Network
MR-DC	Multi-Radio Dual Connectivity
NAS	Network Attached Storage
NB-IoT	Narrowband Internet of Things
NEF	Network Exposure Function
NE-DC	New Radio Evolved Universal Terrestrial Radio Access Dual Connectivity
NF	Network Functions
NGEN-DC	Next Generation Radio Access Network Evolved Universal Terrestrial Radio Access-New Radio Dual Connectivity
ng-eNB	Next Generation E-Node B
NR	New Radio
NRF	Network Repository Function
NR-DC	New-Radio Dual Connectivity
NS	Network Slices
NSA	Non-standalone
NSSAI	Network Slice Selection Assistance Information
NSSF	Network Slice Selection Function
OFDM	Orthogonal Frequency Division Multiplexing
PCEF	Policy and Charging Enforcement Function
PCF	Policy Control Function
PDU	Protocol Data Unit
PGW-C	Packet Data Network Gateway Control
PLMN	Public Land Mobile Network
QCI	QoS Class Identifier
QoS	Quality of Service
RAT	Radio Access Technology
RIT	Radio Interface Technologies

RRC	Radio Resource Control
SA	Standalone
SBA	Service-Based Architecture
SDF	Service Data Flow
SEAF	Security Anchor Function
SEES	Service Exposure and Enablement Support
SEPP	Security Edge Protection Proxy
SGW-C	Serving Gateway Control
SIDF	Subscription Identifier De-Concealing Function
SM	Session Management
SMF	Session Management Function
SMS	Short Message Service
SRIT	Set of Radio Interface Technologies
SUCI	Subscription Concealed Identifier
SUL	Supplementary Uplink
SUPI	Subscription Permanent Identifier
TDD	Time Division Duplex
TPC	Transmit Power Control
TXRU	Transceiver Unit
UDM	Unified Data Management
UDR	Unified Data Repository
UE	User Equipment
UL	Uplink
UPF	User Plane Functions
URLLC	Ultra-Reliable Low Latency Communications
V2X	Vehicle-to-everything
VPLMN	Visited Public Land Mobile Network

Annex C (normative)

IMT-2020 radio interface technical performance

C.1 Requirements of technical performance for IMT-2020 radio interface(s)

The requirements of technical performance for IMT-2020 radio interface(s) are stipulated in ITU-R M.2410-0 as shown in Table C.1.

Table C.1. IMT-2020 radio interface technical requirements

Parameter	Indoor hotspot (eMBB)	Dense urban (eMBB)	Rural (eMBB)	Urban macro (mMTC)	Urban macro (URLLC)	Evaluation methodology
Peak data rate	Downlink: 20 Gbps Uplink: 10 Gbps			N/A	N/A	Analytical
Peak spectral efficiency	Downlink: 30 bps/Hz Uplink: 15 bps/Hz			N/A	N/A	Analytical
User experience data rate	N/A	Downlink: 100 Mbps Uplink: 50 Mbps	N/A	N/A	N/A	Analytical for single band and single layer cell layout. Simulation for multilayer cell layout
5th percentile user spectral efficiency	Downlink: 0.3 bps/Hz Uplink: 0.21 bps/Hz	Downlink: 0.225 bps/Hz Uplink: 0.15 bps/Hz	Downlink: 0.12 bps/Hz Uplink: 0.445 bps/Hz	N/A	N/A	Simulation
Average spectral efficiency	Downlink: 9 bps/Hz Uplink: 6.75 bps/Hz	Downlink: 7.8 bps/Hz Uplink: 5.4 bps/Hz	Downlink: 3.3 bps/Hz Uplink: 1.6 bps/Hz	N/A	N/A	Simulation
Area traffic capacity	10 Mbps/m ²	N/A	N/A	N/A	N/A	Analytical
Latency user plane	4 ms			N/A	1 ms	Analytical
Latency control plane	20 ms			N/A	20 ms	
Connection density	N/A	N/A	N/A	1,000,000 device/km ²	N/A	Analytical

Table C.1. IMT-2020 radio interface technical requirements (continued)

Parameter	Indoor hotspot (eMBB)	Dense urban (eMBB)	Rural (eMBB)	Urban macro (mMTC)	Urban macro (URLLC)	Evaluation methodology
Energy efficiency	Shall have the capability to support a high sleep ratio and long sleep duration			N/A	N/A	Simulation
Reliability	N/A	N/A	N/A	N/A	1 - 10 ⁻⁵ success probability of transmitting a layer 2 PDU of 32 bytes within 1 ms	Inspection
Mobility	Normalised traffic channel link data rates of 1.5 bps/Hz at 10 km/h in the uplink	Normalised traffic channel link data rates of 1.12 bps/Hz at 30 km/h in the uplink	Normalised traffic channel link data rates of 0.8 and 0.45 bps/Hz at 120 km/h and 500 km/h respectively in the uplink	N/A	N/A	Simulation
Mobility interruption time	0 ms			N/A	0 ms	Analytical
Bandwidth	Minimum of 100 MHz for operation in FR1 Minimum of 1 GHz for operation in higher frequency bands (FR2)					Inspection

C.2 User plane procedure for evaluation of user plane latency

The user plane procedure for evaluation of latency is shown in Figure C.1

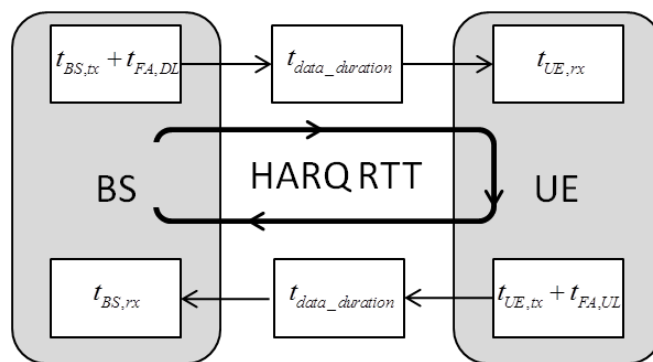

Figure C.1. User plane procedure for evaluation of user plane latency

MCMC MTSFB TC G027:2021

C.3 DL/UL user experience data rates for NR in dense urban for eMBB

DL/UL user experience data rates for NR in dense urban for eMBB self-evaluation studies are defined in 3GPP TR 37.910 using configuration A and C as shown in Table C.2 to C.7.

Table C.2. DL evaluation configuration A (single band), CF = 4 GHz for NR FDD

Scheme and antenna configuration	Sub-carrier spacing	ITU requirements (Mbps)	Channel model A			Channel model B		
			Number of samples	Assumed DL system bandwidth (MHz)	User experience data rate (Mbps)	Number of samples	Assumed DL system bandwidth (MHz)	User experience data rate (Mbps)
32x4 MU-MIMO Type II codebook; gNB config = (8,8,2,1,1;2,8)	15	100	11	240	108.33	8	240	105.30
32x4 MU-MIMO Type I codebook; gNB config = (8,8,2,1,1;2,8)	15	100	2	280	112.86	-	-	-
32x4 MU-MIMO Type II codebook; gNB config = (8,16,2,1,1;1,16)	15	100	1	160	104.66	-	-	-
32x4 MU-MIMO Type II codebook; gNB config = (16,8,2,1,1;2,8)	15	100	1	200	107.02	1	200	105.81
4x4 MU-MIMO Type II codebook; gNB config = (8,8,2,1,1;2,1)	15	100	1	240	112.64	-	-	-

Table C.2. DL evaluation configuration A (single band), CF = 4 GHz for NR FDD (continued)

Scheme and antenna configuration	Sub-carrier spacing	ITU requirements (Mbps)	Channel model A			Channel model B		
			Number of samples	Assumed DL system bandwidth (MHz)	User experience data rate (Mbps)	Number of samples	Assumed DL system bandwidth (MHz)	User experience data rate (Mbps)
32x8 MU-MIMO Type II codebook; gNB config = (16,8,2,1,1;2,8)	15	100	1	280	111.68	-	-	-
NOTE: The antenna configuration is indicated as (M,N,P,Mg,Ng;Mp,Np), where M and N are the number of vertical, horizontal antenna elements within a panel, P is number of polarisations, Mg is the number of panels in a column, Ng is the number of panels in row; and Mp and Np are the number of vertical and horizontal Transceiver Units (TXRUs) within a panel and polarisation.								

Table C.3. DL evaluation configuration A (single band), CF = 4 GHz for NR TDD

Scheme and antenna configuration	Sub-carrier spacing	Frame structure	ITU requirement (Mbps)	Channel model A			Channel model B		
				Number of samples	Assumed system bandwidth (MHz)	User experience data rate (Mbps)	Number of samples	Assumed system bandwidth (MHz)	User experience data rate (Mbps)
32x4 MU-MIMO, Reciprocity based; 4T SRS; gNB config = (8,8,2,1,1;2,8)	30	DDDSU, S slot =10DL:2GP:2UL	100	3	300	138.60	3	300	129.45
32x4 MU-MIMO, Reciprocity based; 4T SRS; gNB config = (8,8,2,1,1;2,8)	30	DDDSU, S slot =11DL:1GP:2UL	100	1	300	137.16	-	-	-

MCMC MTSFB TC G027:2021

Table C.3. DL evaluation configuration A (single band), CF = 4 GHz for NR TDD (continued)

Scheme and antenna configuration	Sub-carrier spacing	Frame structure	ITU requirement (Mbps)	Channel model A			Channel model B		
				Number of samples	Assumed system bandwidth (MHz)	User experience data rate (Mbps)	Number of samples	Assumed system bandwidth (MHz)	User experience data rate (Mbps)
32x4 MU-MIMO, Reciprocity based; 4T SRS; gNB config = (8,8,2,1,1;2,8)	15	DDDSU, S slot =10DL:2GP:2UL	100	2	360	104.36	2	320	102.09
64x4 MU-MIMO, Reciprocity based; 4T SRS; gNB config = (12,8,2,1,1;4,8)	30	DDDSU, S slot =10DL:2GP:2UL	100	1	300	144.34	2	200	102.80
64x4 MU-MIMO, Reciprocity based; 4T SRS; gNB config = (12,8,2,1,1;4,8)	15	DDDSU, S slot =10DL:2GP:2UL	100	1	240	100.87	1	240	102.57
32x4 MU-MIMO, Type II Codebook; gNB config = (8,16,2,1,1;1,16)	15	DSUUD S slot =6DL:2GP:6UL	100	1	400	105.37	-	-	-
32x4 MU-MIMO, Reciprocity based; 4T SRS; gNB config = (16,8,2,1,1;2,8)	15	DSUUD S slot =11DL:1GP:2UL	100	1	400	107.44	1	400	104.60

Table C.3. DL evaluation configuration A (single band), CF = 4 GHz for NR TDD (continued)

Scheme and antenna configuration	Sub-carrier spacing	Frame structure	ITU requirement (Mbps)	Channel model A			Channel model B		
				Number of samples	Assumed system bandwidth (MHz)	User experience data rate (Mbps)	Number of samples	Assumed system bandwidth (MHz)	User experience data rate (Mbps)
32x4 MU-MIMO, Reciprocity based; 4T SRS; gNB config = (8,8,2,1,1;2,8)	15	DSUUD S slot =11DL:1GP:2UL	100	2	440	101.81	2	400	104.16
32x4 MU-MIMO, Reciprocity based; 4T SRS; gNB config = (16,8,2,1,1;2,8)	30	DSUUD S slot =11DL:1GP:2UL	100	1	400	123.50	1	400	116.27
64x4 MU-MIMO, Reciprocity based; 4T SRS; gNB config = (12,8,2,1,1;4,8)	15	DSUUD S slot =11DL:1GP:2UL	100	1	280	107.37	1	280	103.20
64x4 MU-MIMO, Reciprocity based; 4T SRS; gNB config = (16,8,2,1,1;4,8)	15	DSUUD S slot =11DL:1GP:2UL	100	1	280	107.91	1	280	110.81
64x4 MU-MIMO, Reciprocity based; 4T SRS; gNB config = (12,8,2,1,1;4,8)	30	DSUUD S slot =11DL:1GP:2UL	100	1	300	126.31	1	300	126.74

MCMC MTSFB TC G027:2021

Table C.3. DL evaluation configuration A (single band), CF = 4 GHz for NR TDD (continued)

Scheme and antenna configuration	Sub-carrier spacing	Frame structure	ITU requirement (Mbps)	Channel model A			Channel model B		
				Number of samples	Assumed system bandwidth (MHz)	User experience data rate (Mbps)	Number of samples	Assumed system bandwidth (MHz)	User experience data rate (Mbps)
64x4 MU-MIMO, Reciprocity based; 4T SRS; gNB config = (12,8,2,1,1;4,8)	30	DSUUD S slot =6DL:2GP:6UL	100	1	300	114.97	1	300	109.22
64x4 MU-MIMO, Reciprocity based; 4T SRS; gNB config = (16,8,2,1,1;4,8)	30	DSUUD S slot =11DL:1GP:2UL	100	1	300	132.83	1	300	135.22
64x8 MU-MIMO, Reciprocity based; 4T SRS; gNB config = (4,32,2,1,1;1,32)	15	DDDSU S slot =10DL:2GP:2UL	100	1	400	108.73	-	-	-
64x4 MU-MIMO, Reciprocity based; 4T SRS; gNB config = (12,8,2,1,1;4,8)	30	DDDDD DDSUU S slot =6DL:4GP:4UL	100	1	300	124.58	-	-	-
32x8 MU-MIMO, Reciprocity based; 2T SRS; gNB config = (16,8,2,1,1;2,8)	15	DSUUD S slot =6DL:2GP:6UL	100	1	560	102.08	-	-	-

Table C.3. DL evaluation configuration A (single band), CF = 4 GHz for NR TDD (concluded)

Scheme and antenna configuration	Sub-carrier spacing	Frame structure	ITU requirement (Mbps)	Channel model A			Channel model B		
				Number of samples	Assumed system bandwidth (MHz)	User experience data rate (Mbps)	Number of samples	Assumed system bandwidth (MHz)	User experience data rate (Mbps)
128x4, MU-MIMO, Reciprocity based; 4T SRS; gNB config = (8,16,2,1,1;4,16)	30	DDSU S slot =10DL:2GP:2UL	100	-	-	-	1	360	111.91
64x4 MU-MIMO, Reciprocity based; 4T SRS; gNB config = (4,8,2,1,1;4,8)	30	DDDSU S slot =10DL:2GP:2UL	100	1	200	119.46	1	200	104.18
16x4 MU-MIMO, Reciprocity based; 4T SRS; gNB config = (8,8,2,1,1;2,8)	30	DDDSU S slot =10DL:2GP:2UL	100	1	300	110.93	1	300	113.01
32x4 MU-MIMO, Reciprocity based; 4T SRS; gNB config = (12,8,2,1,1;4,8)	30	DDDDDDDSUU S slot =6DL:4GP:6UL	100	1	200	107.91	1	300	138.32
64x4 MU-MIMO, Reciprocity based; 4T SRS; gNB config = (12,8,2,1,1;4,8)	30	DDDSUDDSUU S slot =10DL:2GP:2UL	100	1	200	106.39	1	300	149.29

NOTE: The antenna configuration is indicated as (M,N,P,Mg,Ng;Mp,Np), where M and N are the number of vertical, horizontal antenna elements within a panel, P is number of polarisations, Mg is the number of panels in a column, Ng is the number of panels in row; and Mp and Np are the number of vertical and horizontal TXRUs within a panel and polarisation.

MCMC MTSFB TC G027:2021

Table C.4. UL evaluation configuration A (single band), CF = 4 GHz for NR FDD

Scheme and antenna configuration	Sub-carrier spacing	ITU requirements (Mbps)	Channel model A			Channel model B		
			Number of samples	Assumed UL system bandwidth (MHz)	User experience data rate (Mbps)	Number of samples	Assumed UL system bandwidth (MHz)	User experience data rate (Mbps)
2x16 SU-MIMO, OFDMA; gNB config = (8,8,2,1,1;1,8)	15	50	4	240	59.79	1	240	52.48
2x32 SU-MIMO, OFDMA; gNB config = (8,8,2,1,1;2,8)	15	50	2	160	58.50	3	160	53.79
4x32 SU-MIMO, OFDMA; gNB config = (8,8,2,1,1;2,8)	15	50	2	160	66.66	1	160	59.95
4x32 MU-MIMO, OFDMA; gNB config = (8,16,2,1,1;1,16)	15	50	1	120	63.33	-	-	-
4x32 MU-MIMO, OFDMA; gNB config = (16,8,2,1,1;2,8)	15	50	1	200	55.46	-	-	-
4x16 SU-MIMO, OFDMA; gNB config = (8,8,2,1,1;1,8)	15	50	1	160	52.80	1	160	55.84
4x4 SU-MIMO, OFDMA; gNB config = (8,8,2,1,1;2,1)	15	50	1	280	54.50	-	-	-

NOTE: The antenna configuration is indicated as (M,N,P,Mg,Ng;Mp,Np), where M and N are the number of vertical, horizontal antenna elements within a panel, P is number of polarisations, Mg is the number of panels in a column, Ng is the number of panels in row; and Mp and Np are the number of vertical and horizontal TXRUs within a panel and polarisation.

Table C.5. UL evaluation configuration A (single band), CF=4 GHz for NR TDD

Scheme and antenna configuration	Sub-carrier spacing	Frame structure	ITU requirement (Mbps)	Channel model A			Channel model B		
				Number of samples	Assumed system bandwidth (MHz)	User experience data rate (Mbps)	Number of samples	Assumed system bandwidth (MHz)	User experience data rate (Mbps)
2x32 SU-MIMO, codebook based, OFDMA; gNB config = (8,8,2,1,1;2,8)	30	DDDSU S slot =10DL:2GP:2UL	50	1	800	53.68	1	900	54.55
2x32 SU-MIMO, codebook based, OFDMA; gNB config = (8,8,2,1,1;2,8)	15	DDDSU S slot =10DL:2GP:2UL	50	1	800	53.94	1	900	53.83
2x64 SU-MIMO, codebook based, OFDMA; gNB config = (12,8,2,1,1;4,8)	30	DDDSU S slot =10DL:2GP:2UL	50	1	600	51.80	2	600	59.48
2x64 SU-MIMO, codebook based, OFDMA; gNB config = (12,8,2,1,1;4,8)	15	DDDSU S slot =10DL:2GP:2UL	50	1	600	52.24	1	700	50.11
4x32 SU-MIMO, codebook based, OFDMA; gNB config = (8,8,2,1,1;2,8)	30	DDDSU S slot =10DL:2GP:2UL	50	1	700	56.21	1	700	52.61
4x32 SU-MIMO, codebook based, OFDMA; gNB config = (8,8,2,1,1;2,8)	15	DDDSU S slot =10DL:2GP:2UL	50	2	700	55.80	1	800	55.98

MCMC MTSFB TC G027:2021

Table C.5. UL evaluation configuration A (single band), CF=4 GHz for NR TDD (continued)

Scheme and antenna configuration	Sub-carrier spacing	Frame structure	ITU requirement (Mbps)	Channel model A			Channel model B		
				Number of samples	Assumed system bandwidth (MHz)	User experience data rate (Mbps)	Number of samples	Assumed system bandwidth (MHz)	User experience data rate (Mbps)
4x32 MU-MIMO, codebook based, OFDMA; gNB config = (8,16,2,1,1;1,16)	15	DSUUD S slot =6DL:2GP:6UL	50	1	300	73.15	-	-	-
4x16 SU-MIMO, non-codebook based, OFDMA; gNB config = (8,8,2,1,1;1,8)	15	DSUUD S slot =11DL:1GP:2UL	50	1	500	58.82	1	400	55.07
4x16 SU-MIMO, non-codebook based, OFDMA; gNB config = (8,8,2,1,1;1,8)	30	DSUUD S slot =11DL:1GP:2UL	50	1	500	57.08	1	400	61.35
4x16 SU-MIMO, codebook based, OFDMA; gNB config = (8,8,2,1,1;1,8)	15	DSUUD S slot =11DL:1GP:2UL	50	1	500	54.90	1	500	60.35
4x16 SU-MIMO, codebook based, OFDMA; gNB config = (8,8,2,1,1;1,8)	30	DSUUD S slot =11DL:1GP:2UL	50	1	500	50.11	1	400	50.89

Table C.5. UL evaluation configuration A (single band), CF=4 GHz for NR TDD (continued)

Scheme and antenna configuration	Sub-carrier spacing	Frame structure	ITU requirement (Mbps)	Channel model A			Channel model B		
				Number of samples	Assumed system bandwidth (MHz)	User experience data rate (Mbps)	Number of samples	Assumed system bandwidth (MHz)	User experience data rate (Mbps)
2x32 SU-MIMO, codebook based, OFDMA; gNB config = (12,8,2,1,1;4,4)	30	DSUUD S slot =6DL:2GP:6UL	50	-	-	-	1	200	55.44
2x64 SU-MIMO, codebook based, OFDMA; gNB config = (12,8,2,1,1;4,8)	30	DSUUD S slot =6DL:2GP:6UL	50	1	200	59.63	1	200	57.54
4x128, MU-MIMO, codebook based, OFDMA; gNB config = (8,16,2,1,1;4,16)	30	DDSU S slot =10DL:2GP:2UL	50	-	-	-	1	1000	52.92
2x64 SU-MIMO, codebook based, OFDMA; gNB config = (12,8,2,1,1;4,8)	30	DDDSUDDSUU S slot =10DL:2GP:2UL	50	1	300	53.56	1	300	53.77
2x64 SU-MIMO, codebook based, OFDMA; gNB config = (12,8,2,1,1;4,8)	30	DDDDDDDSUU S slot =6DL:4GP:4UL	50	1	500	56.53	1	500	56.77
4x32 SU-MIMO, codebook based, OFDMA; gNB config = (8,8,2,1,1;2,8)	15	DSUUD S slot =11DL:1GP:2UL	50	-	-	-	1	300	50.06

MCMC MTSFB TC G027:2021

Table C.5. UL evaluation configuration A (single band), CF=4 GHz for NR TDD (concluded)

Scheme and antenna configuration	Sub-carrier spacing	Frame structure	ITU requirement (Mbps)	Channel model A			Channel model B		
				Number of samples	Assumed system bandwidth (MHz)	User experience data rate (Mbps)	Number of samples	Assumed system bandwidth (MHz)	User experience data rate (Mbps)
4x32 SU-MIMO, codebook based, OFDMA; gNB config = (8,8,2,1,1;2,8)	15	DDDSU S slot =10DL:2GP:2UL	50	-	-	-	1	800	54.59

NOTE: The antenna configuration is indicated as (M,N,P,Mg,Ng;Mp,Np), where M and N are the number of vertical, horizontal antenna elements within a panel, P is number of polarisations, Mg is the number of panels in a column, Ng is the number of panels in row; and Mp and Np are the number of vertical and horizontal TXRUs within a panel and polarisation.

Table C.6. DL evaluation configuration C (multi band), CF=4 GHz for NR TDD band (macro layer + micro layer)

Scheme and antenna configuration	Sub-carrier spacing	Frame structure	ITU requirement (Mbps)	Channel model A			Channel model B		
				Number of samples	Assumed system bandwidth (MHz)	User experience data rate (Mbps)	Number of samples	Assumed system bandwidth (MHz)	User experience data rate (Mbps)
Macro and micro layer : 32x4 MU-MIMO, 4T SRS; gNB config = (8,8,2,1,1; 2,8)	Macro and micro layer: 30	Macro and micro layer: DDDSU S slot =10DL:2GP:2UL	100	-	-	-	1	260	127.66

NOTE: The antenna configuration is indicated as (M,N,P,Mg,Ng;Mp,Np), where M and N are the number of vertical, horizontal antenna elements within a panel, P is number of polarisations, Mg is the number of panels in a column, Ng is the number of panels in row; and Mp and Np are the number of vertical and horizontal TXRUs within a panel and polarisation.

Table C.7. UL evaluation configuration C (multi band), CF = 70 GHz for NR TDD + Supplemental UL (SUL) (macro layer only)

Scheme and antenna configuration	Sub-carrier spacing	Frame structure	ITU requirement (Mbps)	Channel model A			Channel model B		
				Number of samples	Assumed system bandwidth (MHz)	User experience data rate (Mbps)	Number of samples	Assumed system bandwidth (MHz)	User experience data rate (Mbps)
4 GHz (SUL band): 2x32 SU-MIMO, codebook based OFDMA gNB config = (8,8,2,1,1; 2,8) 30 GHz (TDD band): 8x32 SU-MIMO, codebook based, OFDMA (2 panel@UE) gNB config = (4,8,2,2,2; 1,4) UE config = (2,4,2,1,2; 1,2) 50% offload to SUL band	4 GHz: 15 30 GHz: 60	4 GHz: full UL; 30 GHz: DDDSU S slot =10DL:2GP:2UL	50	1	4 GHz: 100 (for UL) 30 GHz: 1200	53.13	1	4 GHz: 100 (for UL) 30 GHz: 1200	51.39

NOTE: The antenna configuration is indicated as (M,N,P,Mg,Ng;Mp,Np), where M and N are the number of vertical, horizontal antenna elements within a panel, P is number of polarisations, Mg is the number of panels in a column, Ng is the number of panels in row; and Mp and Np are the number of vertical and horizontal TXRUs within a panel and polarisation.

Bibliography

- [1] 3GPP Release 15: TS 23.501, *3rd Generation Partnership Project; 5G: System Architecture for the 5G System; Technical Specification (Release 15)*
- [2] 3GPP Release 15: TS 23.502, *3rd Generation Partnership Project; 5G: Procedures for the 5G System (5GS); Technical Specification (Release 15)*
- [3] 3GPP Release 15: TS 38.410, *3rd Generation Partnership Project; 5G; NG-RAN; NG general aspects and principles; Technical Specification (Release 15)*
- [4] GSM Association, Report, Road to 5G: Introduction and Migration, April 2018

Acknowledgements

Members of the International Mobile Telecommunications 2020 Sub Working Group

Mr Anwar Faizd Osman (Chairman)	Rohde & Schwarz Malaysia
Ts Mohammad Hafiz Halal /	Malaysian Technical Standards Forum Bhd
Mr Ahmad Syazilie Shamsuddin (Secretariat)	
Mr Low Kien Yap	Celcom Axiata Berhad
Mr Mohd Riza Sulaiman	
Mr Muhammad Rezza Alui	Digi Telecommunications Sdn Bhd
Mr Sharadindoo Sadhu	Fraunhofer IIS
Mr Dikhwan Hady Darnalis /	Huawei Technologies (Malaysia) Sdn Bhd
Mr Khor Shin Yew /	
Mr. Chan Kok Hong	
Ir Dr Khaizuran Abdullah /	International Islamic University Malaysia
Prof Md Rafiqul Islam	
Mr Rakuram Gandhi /	Maxis Broadband Sdn Bhd
Ms Ang Su Yuong /	
Mr Wong Chup who	
Prof Mohamad Yusoff Alias /	Multimedia University
Ts Ir Jason Lee Lian Hong /	
Dr Ivan Ku Chui Choon	
Ts Dr Jeffrey Bannister /	Orbitage Sdn. Bhd
Ms Kong Mun Yeen	
Mr. Chong Kok Onn /	Tekmark Sdn Bhd
Mr Andy Loo Chee Kean	
Mr Yeoh Chun Yeow	Telekom Malaysia Berhad
Mr Najib Fadil Bin Mohd Bisri @ Bisri	

Ms Ng Hsiao Ying /	U Mobile Sdn Bhd;
Mr Yeat Choo Hang /	
Mr Ng Chow Yong	
Prof Mohammad Tariqul Islam	Universiti Kebangsaan Malaysia
Prof Aduwati Sali	Universiti Putra Malaysia
Dr Imran Mohd Ibrahim	Universiti Teknikal Malaysia Melaka
Prof Tharek Abd Rahman /	Universiti Teknologi Malaysia
Prof Sharul Kamal Abdul Rahim /	
Dr Bruce Leow Chee Yen /	
Dr Rudzidatul Akmam Dziauddin	
Prof Mohammad Faiz Liew Abdullah	Universiti Tun Hussein Onn Malaysia
Ms Siti Najwa Muhammad /	Webe Digital Sdn Bhd
Mr Khairul Akmal Zahri	
Mr Low Wei Yap	Wideminds Pte Ltd
Ms Norehan Yahya	Xcelcius Consultancy Sdn Bhd
Mr Azmarhisyam Omar /	YTL Communications Sdn Bhd
Mr Yew Kuan Min	

By invitation:

Mr Chong Chee Wah /	Ericsson (M) Sdn Bhd
Mr Afrizal Abdul Rahim /	
Mr Frank Hayward	
Ir Dr Nordin Ramli	MIMOS Berhad
Ms Irina Khmeleva	Nokia Services and Solutions Sdn Bhd
Ts Dr Kesavan Ulaganathen	Politeknik Sandakan Sabah